

# Kratom: Trends, Adverse Effects, and Public Health Implications

William Eggleston, PharmD, DABAT  
Assistant Clinical Director  
Upstate New York Poison Center



**Opioid  
Response  
Network**



# Working with communities.

- ✧ The SAMHSA-funded *Opioid Response Network (ORN)* assists states, tribes, organizations and individuals by providing the resources and technical assistance they need locally to address the opioid crisis and stimulant use.
- ✧ Technical assistance is available to support the evidence-based prevention, treatment and recovery of opioid use disorders and stimulant use disorders.



# Working with communities.

- ✧ The *Opioid Response Network (ORN)* provides local, experienced consultants in prevention, treatment and recovery to communities and organizations to help address this opioid crisis and stimulant use.
- ✧ *ORN* accepts requests for education and training.
- ✧ Each state/territory has a designated team, led by a regional Technology Transfer Specialist (TTS), who is an expert in implementing evidence-based practices.



# Contact the Opioid Response Network

- ✦ To ask questions or submit a technical assistance request:
  - Visit [www.OpioidResponseNetwork.org](http://www.OpioidResponseNetwork.org)
  - Email [orn@aaap.org](mailto:orn@aaap.org)



# Substance Abuse and Mental Health Services Administration (SAMHSA)

*Funding for this initiative was made possible (in part) by grant no. 1H79TI088037 from SAMHSA. The views expressed in written conference materials or publications and by speakers and moderators do not necessarily reflect the official policies of the Department of Health and Human Services; nor does mention of trade names, commercial practices, or organizations imply endorsement by the U.S. Government.*



# Objectives

Discuss kratom use in the United States, including motivation for use, formulations, dosing, and demographics.

Describe the potential benefits and risks of kratom use.

Evaluate strategies for treatment and shared decision making in patients using kratom.







# U.S. Carfentanil Deaths

↑ 720.7%

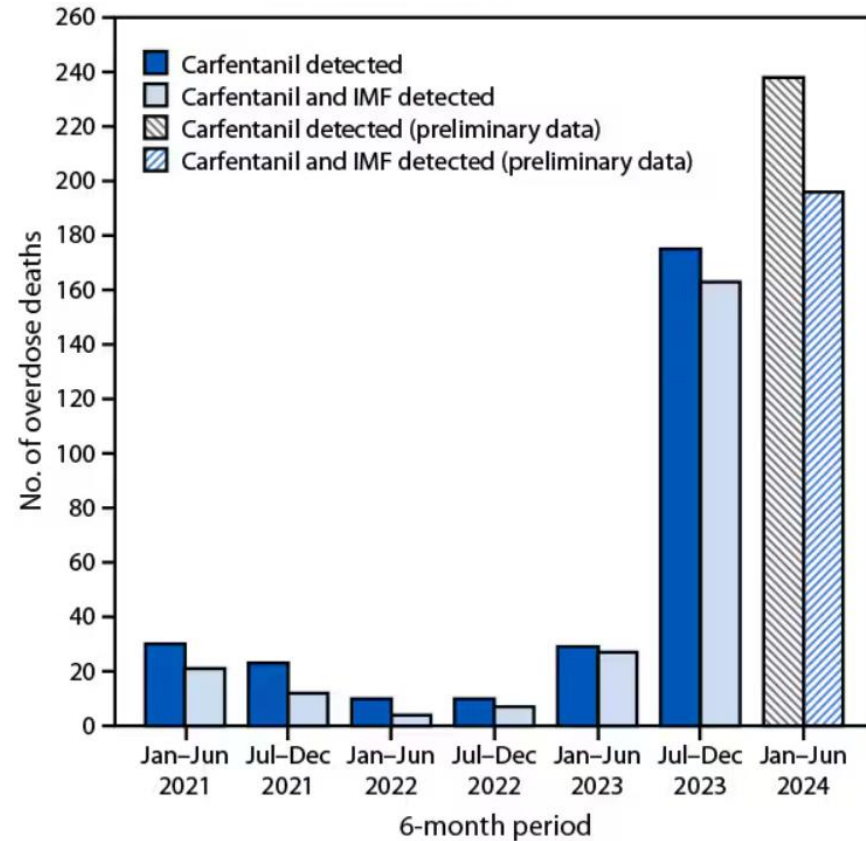

Tanz LJ et al. Morb Mortal Wkly Rep. 2024; 73:1099–1105.



# U.S. Overdose Deaths 2021-2023

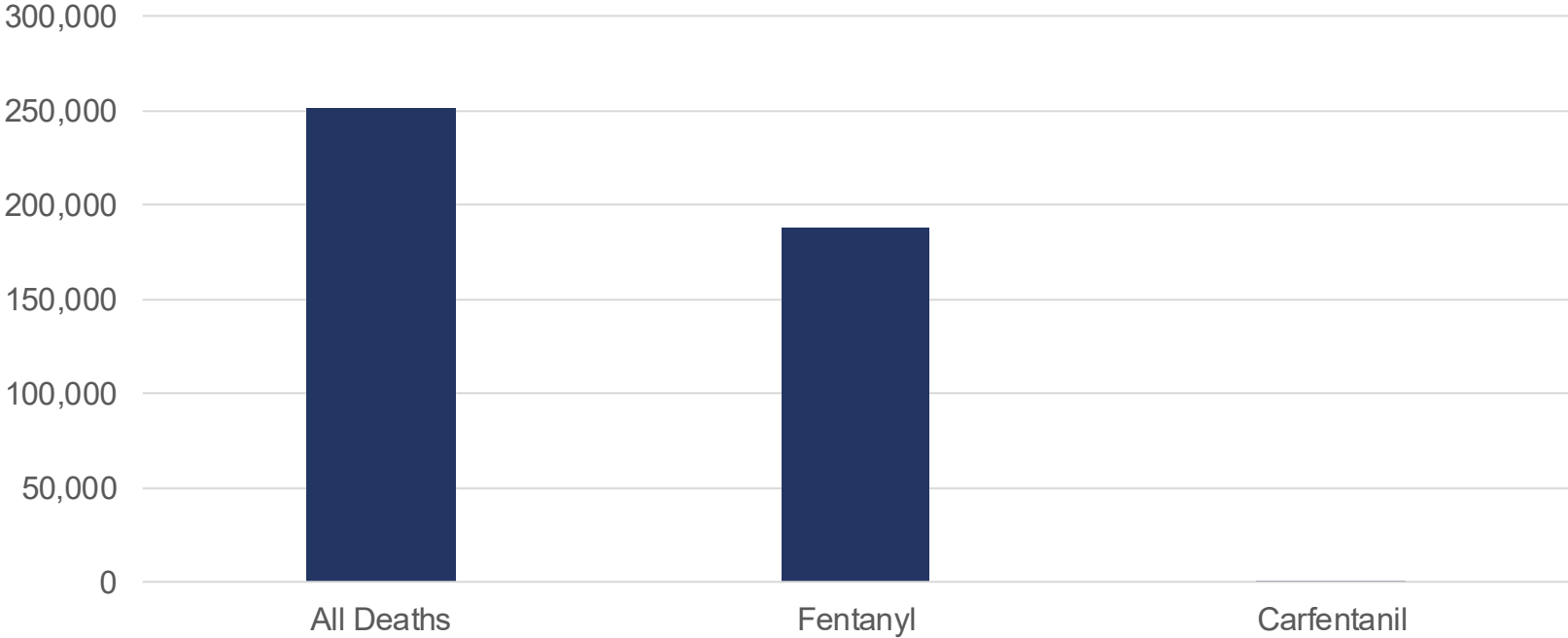

Tanz LJ et al. *Morb Mortal Wkly Rep.* 2024; 73:1099–1105.





# Drug Trends

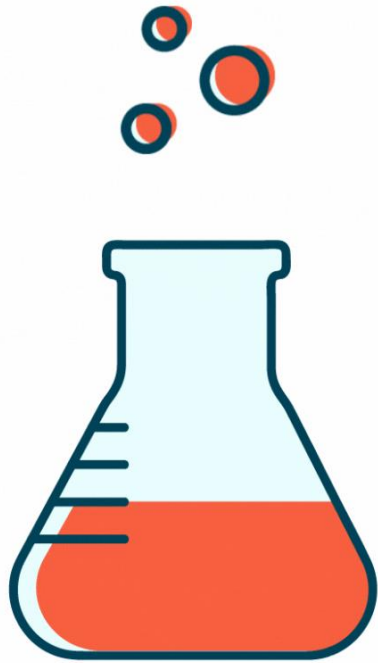



# DRUGSData.ORG

Erowid's anonymous drug analysis program  
Formerly called EcstasyData

[Test Results](#)

[Test Result Statistics](#)

[About Tests & Data](#)

[About Us](#)

[Contact Us](#)

[FAQ](#)

	<a href="#">White Powder</a> Sold as: 3-MMC / 3-Methylmethcathinone	<ul style="list-style-type: none"><li>3-CMC</li><li>iso-3-CMC</li></ul>		Aug 24, 2024 (Tested: Jun 14, 2024)	Zurich, Switzerland	<a href="#">SaferParty.ch</a> [ <a href="#">Direct Link</a> ]
	<a href="#">White Powder</a> Sold as: 3-MMC / 3-Methylmethcathinone	<ul style="list-style-type: none"><li>3-CMC</li><li>iso-3-CMC</li></ul>		Aug 24, 2024 (Tested: Jun 15, 2024)	Zurich, Switzerland	<a href="#">SaferParty.ch</a> [ <a href="#">Direct Link</a> ]
	<a href="#">Majora's Mask</a> Zelda; Triforce Sold as: MDMA / Ecstasy	<ul style="list-style-type: none"><li>2C-B</li><li>Synthesis Byproduct(s)</li></ul>	<ul style="list-style-type: none"><li>17.0 mg</li><li>1.2</li></ul>	Aug 24, 2024 (Tested: Jun 19, 2024)	Bern, Switzerland	<a href="#">SaferParty.ch</a> [ <a href="#">Direct Link</a> ]
	<a href="#">Philipp Plein</a> Sold as: MDMA / Ecstasy	<ul style="list-style-type: none"><li>MDMA</li></ul>	<ul style="list-style-type: none"><li>245.80 mg</li></ul>	Aug 24, 2024 (Tested: Jun 08, 2024)	Basel, Switzerland	<a href="#">SaferParty.ch</a> [ <a href="#">Direct Link</a> ]
	<a href="#">White Powder</a> Sold as: MDMA / Ecstasy	<ul style="list-style-type: none"><li>3-Methylmethcathinone</li></ul>		Aug 24, 2024 (Tested: Jun 06, 2024)	Lausanne, Switzerland	<a href="#">SaferParty.ch</a> [ <a href="#">Direct Link</a> ]
	<a href="#">Kant FR</a> Sold as: MDMA / Ecstasy	<ul style="list-style-type: none"><li>MDMA</li></ul>	<ul style="list-style-type: none"><li>147 mg</li></ul>	Aug 24, 2024 (Tested: Jun 08, 2024)	Zurich, Switzerland	<a href="#">SaferParty.ch</a> [ <a href="#">Direct Link</a> ]
	<a href="#">Kant FR</a> Sold as: MDMA / Ecstasy	<ul style="list-style-type: none"><li>MDMA</li></ul>	<ul style="list-style-type: none"><li>176.50 mg</li></ul>	Aug 24, 2024 (Tested: Jun 08, 2024)	Basel, Switzerland	<a href="#">SaferParty.ch</a> [ <a href="#">Direct Link</a> ]
	<a href="#">Totenkopf / MyBrand</a> Skull Sold as: MDMA / Ecstasy	<ul style="list-style-type: none"><li>MDMA</li></ul>	<ul style="list-style-type: none"><li>215.20 mg</li></ul>	Aug 24, 2024 (Tested: Jun 12, 2024)	Bern, Switzerland	<a href="#">SaferParty.ch</a> [ <a href="#">Direct Link</a> ]
	<a href="#">The Punisher</a> Sold as: MDMA / Ecstasy	<ul style="list-style-type: none"><li>MDMA</li></ul>	<ul style="list-style-type: none"><li>209.90 mg</li></ul>	Aug 24, 2024 (Tested: Jun 07, 2024)	Zurich, Switzerland	<a href="#">SaferParty.ch</a> [ <a href="#">Direct Link</a> ]
	<a href="#">Prada Holland</a> Sold as: MDMA / Ecstasy	<ul style="list-style-type: none"><li>MDMA</li></ul>	<ul style="list-style-type: none"><li>233.80 mg</li></ul>	Aug 24, 2024 (Tested: Jun 11, 2024)	Lucerne, Switzerland	<a href="#">SaferParty.ch</a> [ <a href="#">Direct Link</a> ]
	<a href="#">Pop Smoke</a> Sold as: MDMA / Ecstasy	<ul style="list-style-type: none"><li>MDMA</li></ul>	<ul style="list-style-type: none"><li>261.10 mg</li></ul>	Aug 24, 2024 (Tested: Jun 12, 2024)	Bern, Switzerland	<a href="#">SaferParty.ch</a> [ <a href="#">Direct Link</a> ]





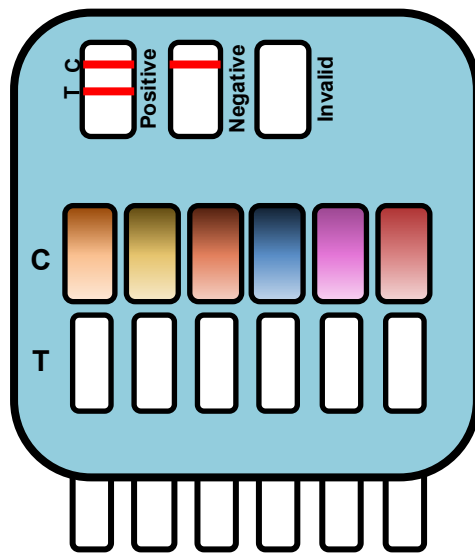





**Kratom**







# US Kratom Interest

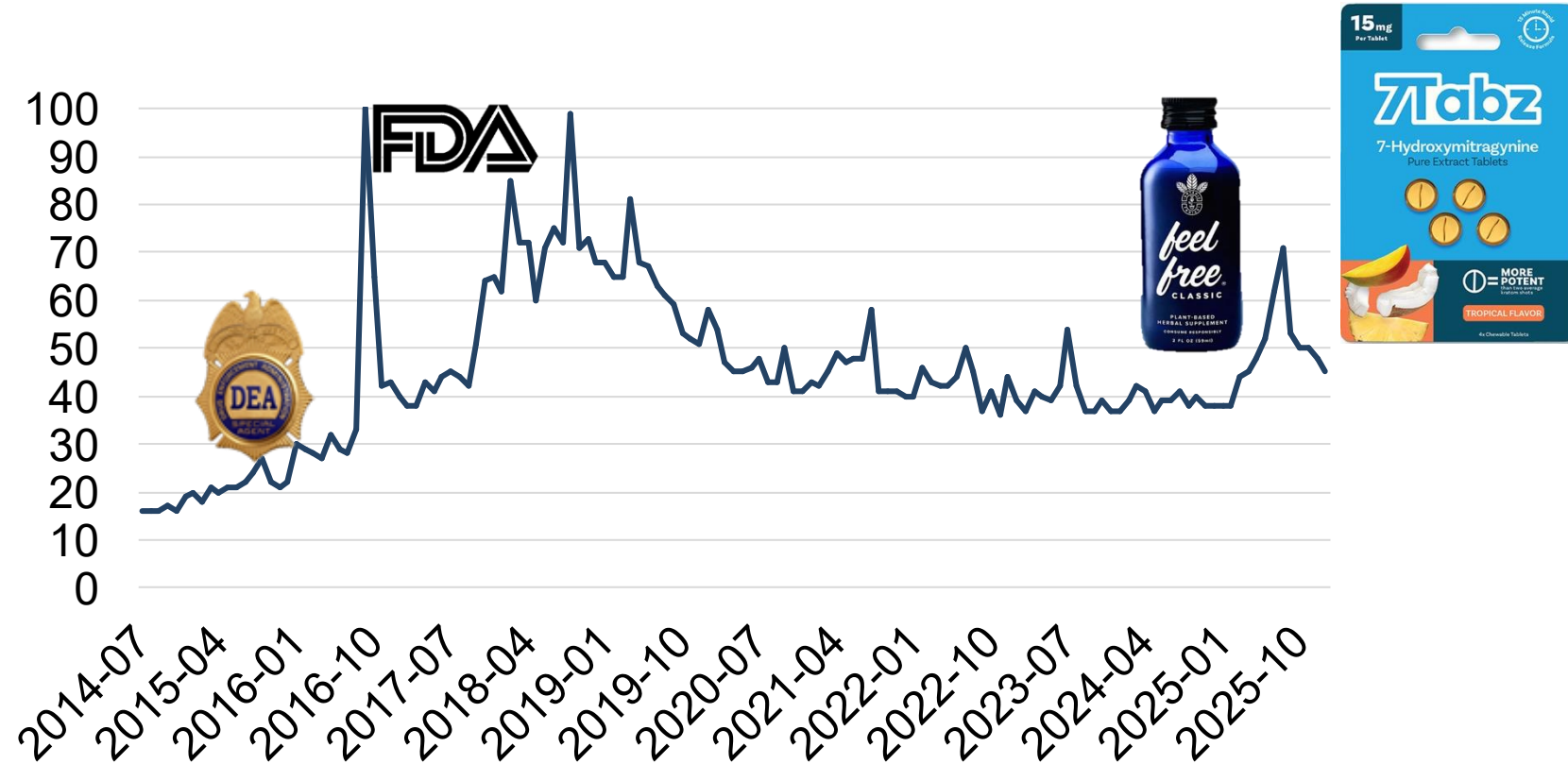



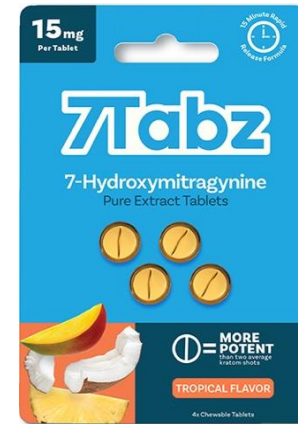

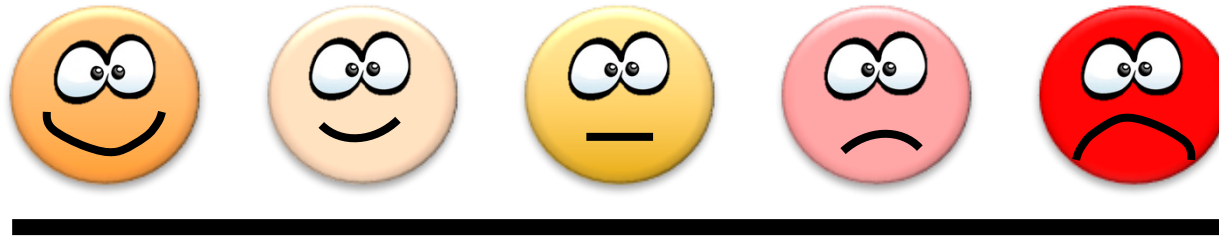

# Motivating Factors

	N (%)	Mean Efficacy (SD)
Just to feel less crappy in general and improve quality of life.	86 (66.7)	74.2 (±21.9)
Self-treat anxiety symptoms.	69 (53.5)	69.4 (±22.9)
Address occasional feelings of sleepiness or low energy.	65 (50.4)	78.0 (±21.2)
Relieve short-term pain (acute pain management)	64 (49.6)	71.9 (±22.1)
For recreation, fun, or to relax.	63 (48.8)	72.4 (±24.6)
Boost energy, stamina and/or endurance (for work, exercise).	62 (48.1)	77.1 (±21.8)
Reduce social anxiety.	60 (46.5)	75.8 (±17.4)
Self-treat depression symptoms.	54 (41.8)	66.6 (±22.7)
Self-treat long-term pain issues and symptoms (chronic pain management)	46 (35.7)	72.1 (±21.6)
Kratom is safer than other substances.	43 (33.3)	90.4 (±11.2)
To achieve a euphoric high.	39 (30.2)	70.9 (±22.3)
As a short-term substitute/replacement for opioids (prescription opioids, heroin).	32 (24.8)	66.7 (±27.1)

# Kratom Alkaloids

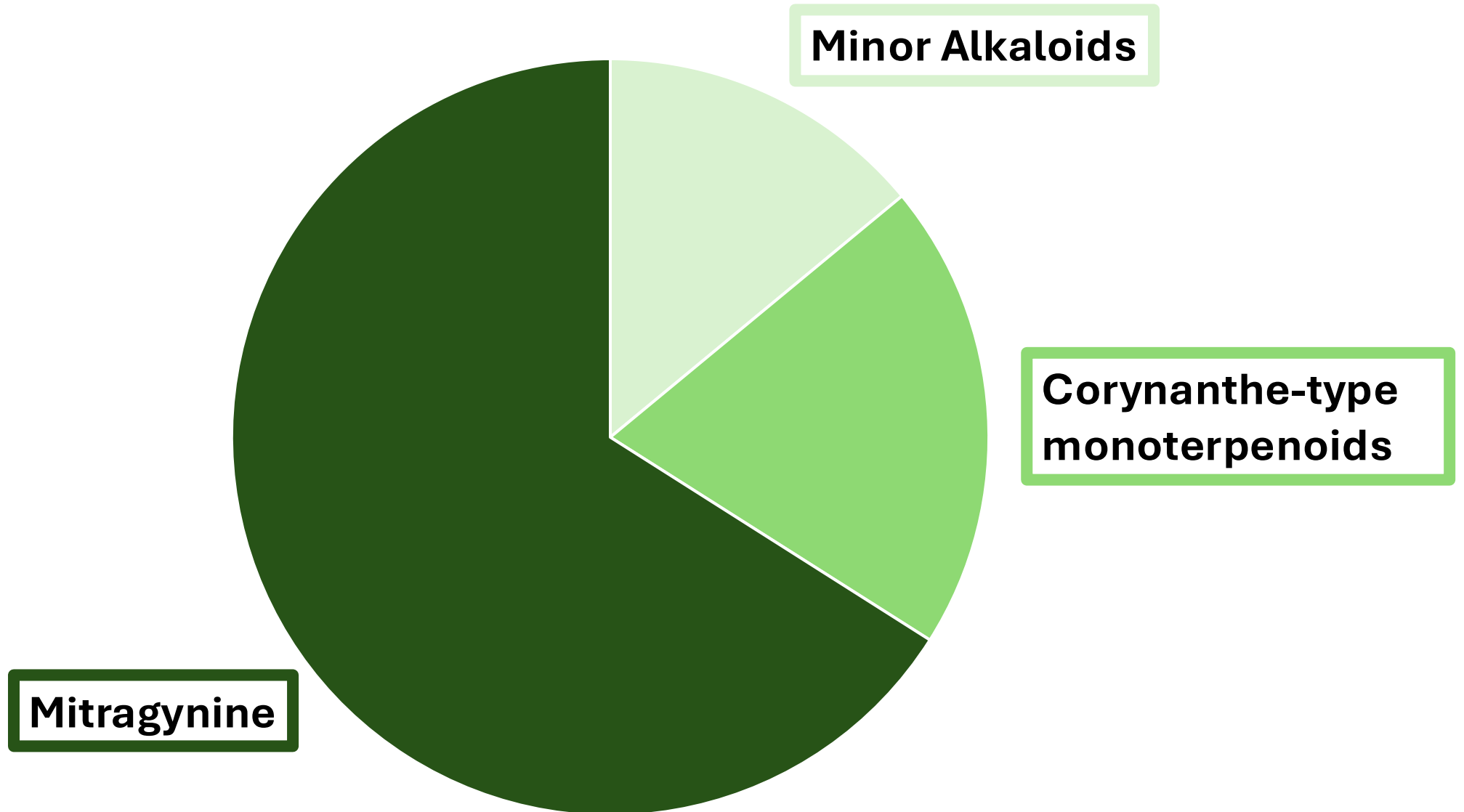



Mitragynine

7-OH-Mitragynine

338.18 mg/oz

ND



4.6 mg/capsule

ND



8.7 mg/gram

ND

Mitragynine

7-OH-Mitragynine



58.92 mg/tab

ND



0.4 mg/tab

15.27 mg/tab



# Mean Alkaloid Concentration

Alkaloid	White Maeng Da	Red Maeng Da	Green Bali	White Thai	Green Maeng Da	Red Bali	<i>p</i> -value
Mitragynine	1.54%	1.52%	1.44%	1.41%	1.56%	1.4%	0.362
Paynantheine	0.28%	0.3%	0.28%	0.27%	0.29%	0.27%	0.917
Speciogynine	0.22%	0.23%	0.22%	0.21%	0.22%	0.21%	0.803
Speciociliatine	0.4%	0.32%	0.35%	0.36%	0.35%	0.32%	0.762

# Kratom Alkaloids

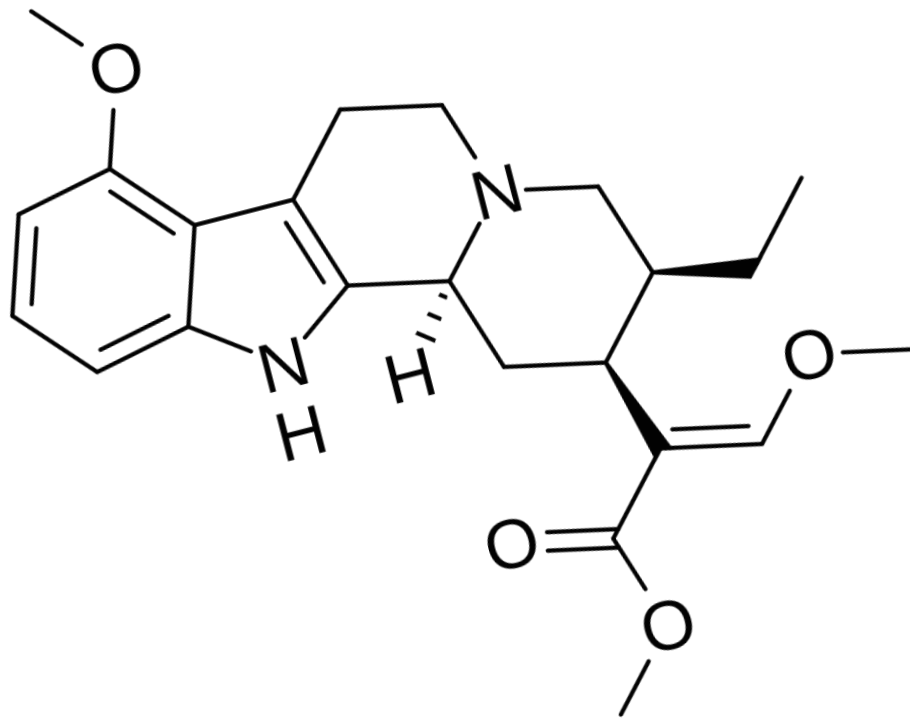

Mitragynine

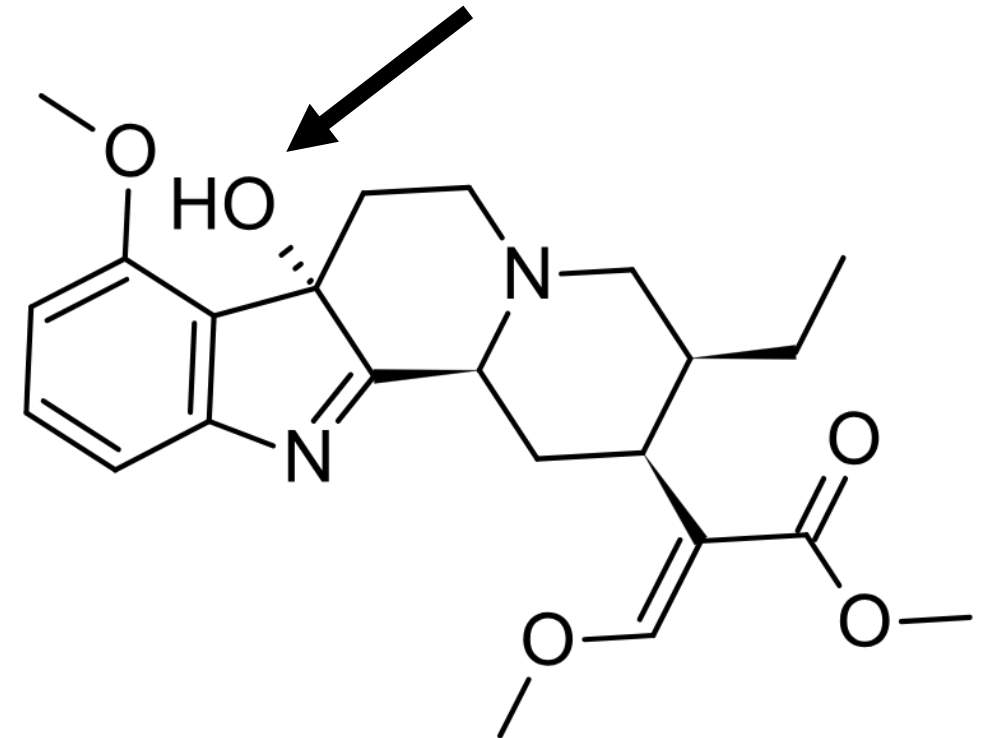

7-Hydroxymitragynine

# Receptor Activity

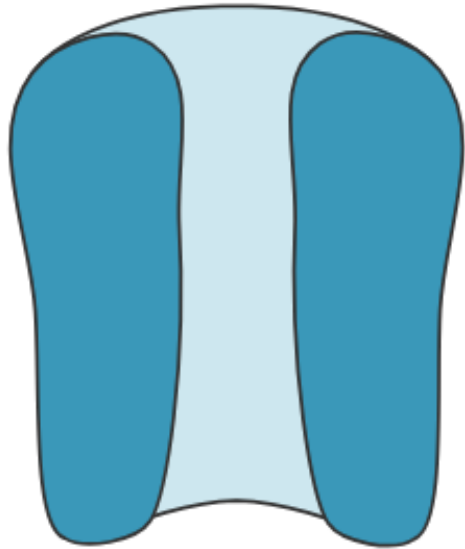

Opioid ( $\mu$ ,  $\delta$ ,  $\kappa$ )

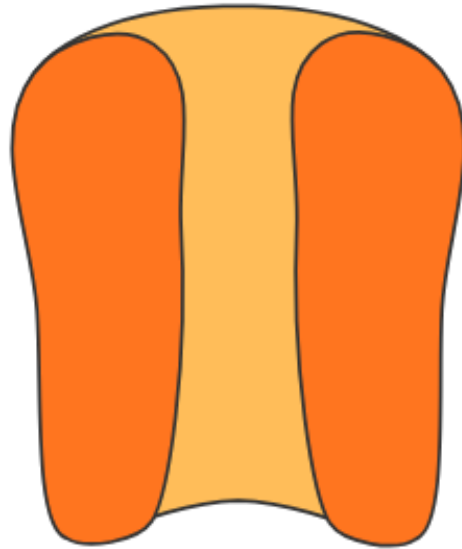

Serotonin (5-HT1A/2A/2B)

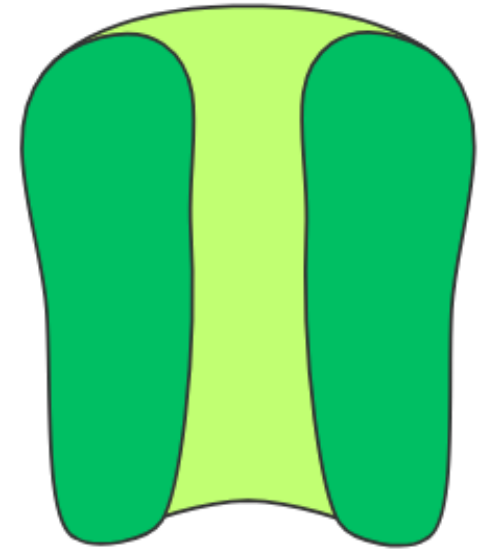

Adrenergic

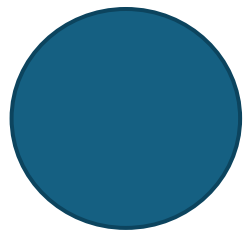
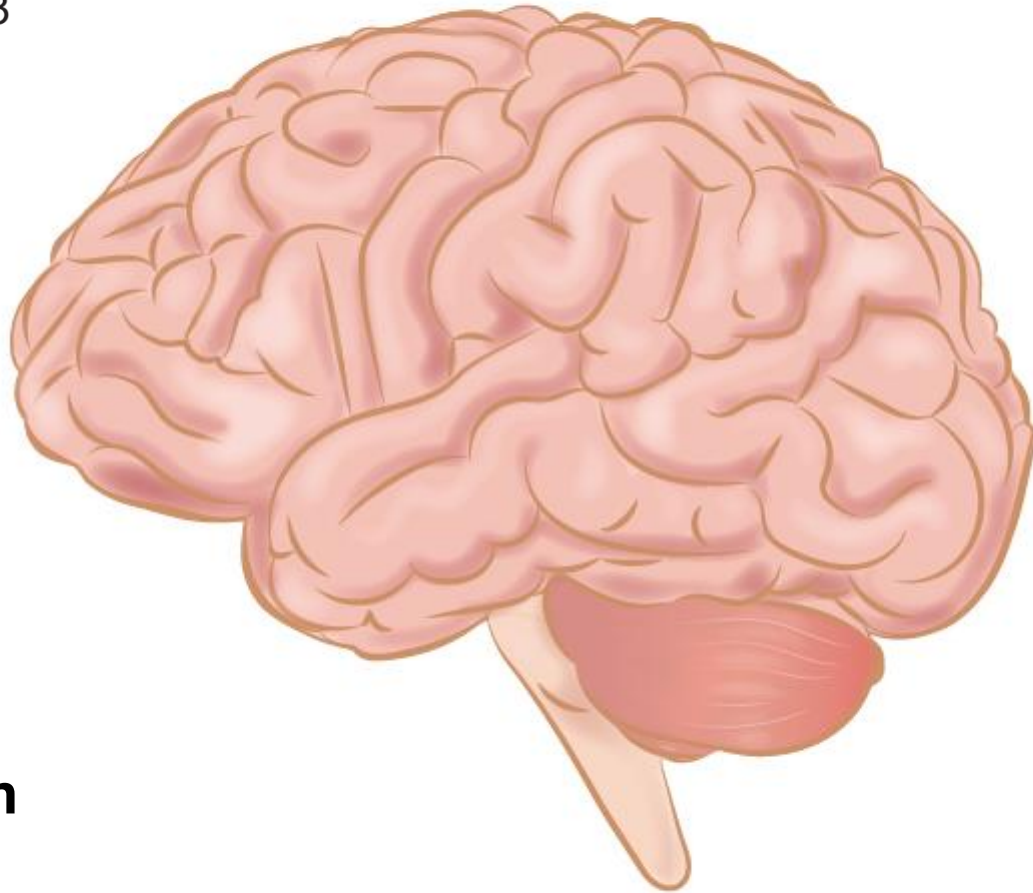
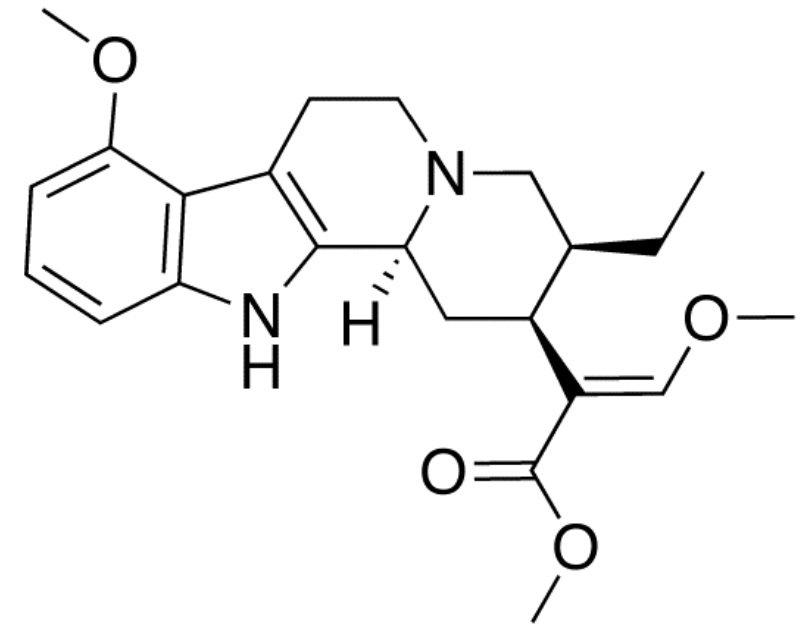
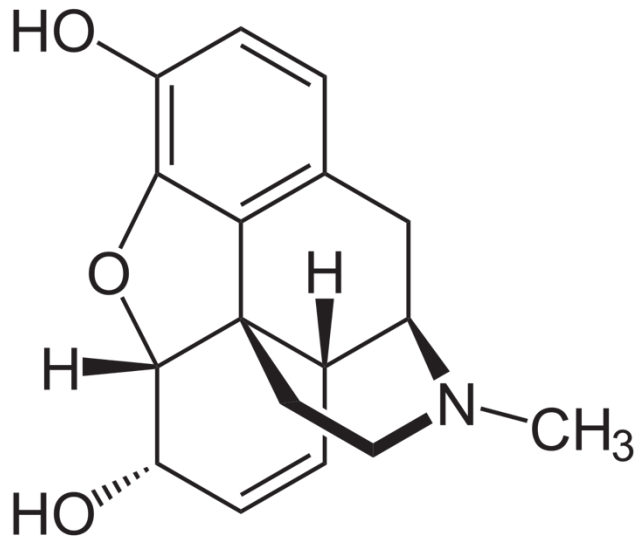

$\beta$ -Arrestin 2

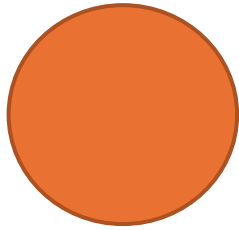

G-Protein

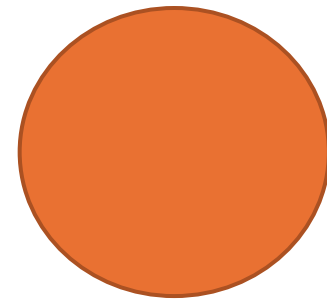

G-Protein



$\beta$ -Arrestin 2

# Kratom Dose

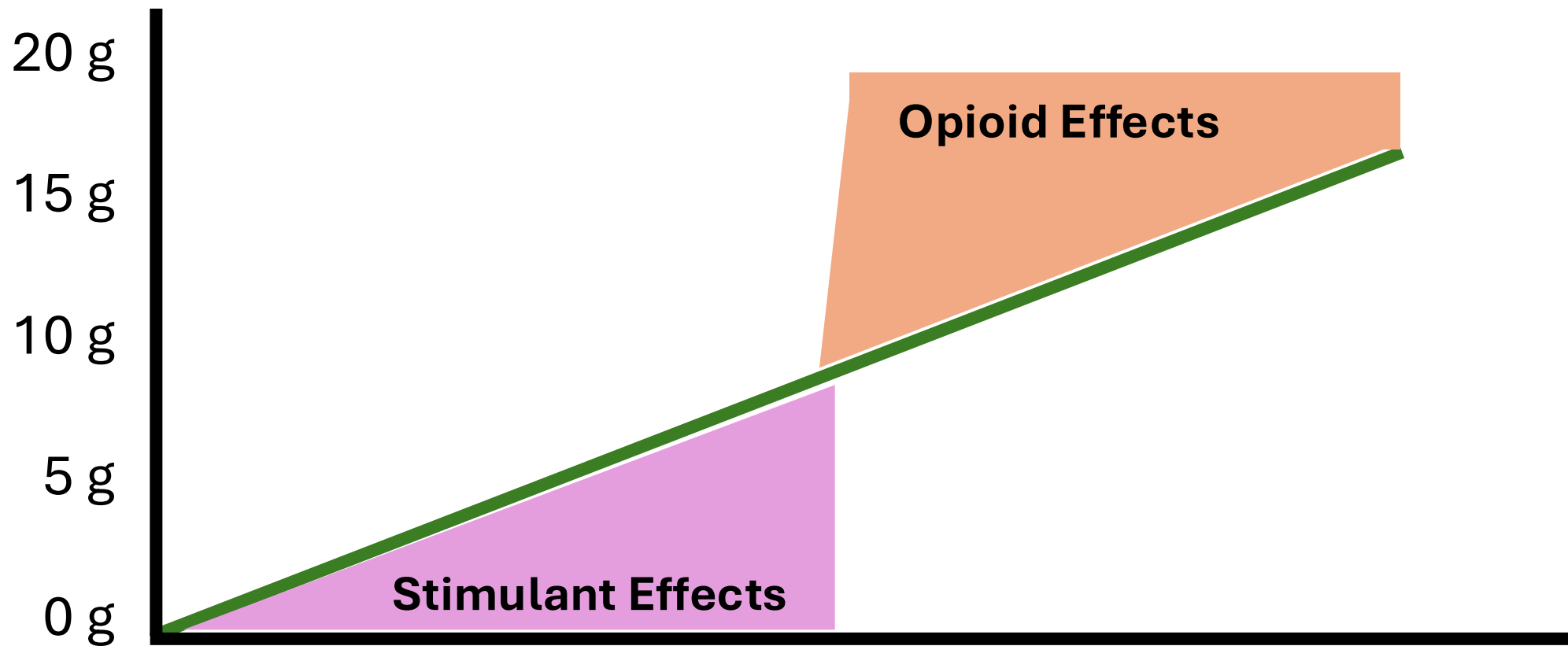

CNS Depression  
Nausea/Constipation  
Dependence/SUD  
Withdrawal



Tachycardia/HTN  
Seizures  
Hepatotoxicity





# Kratom Metabolism

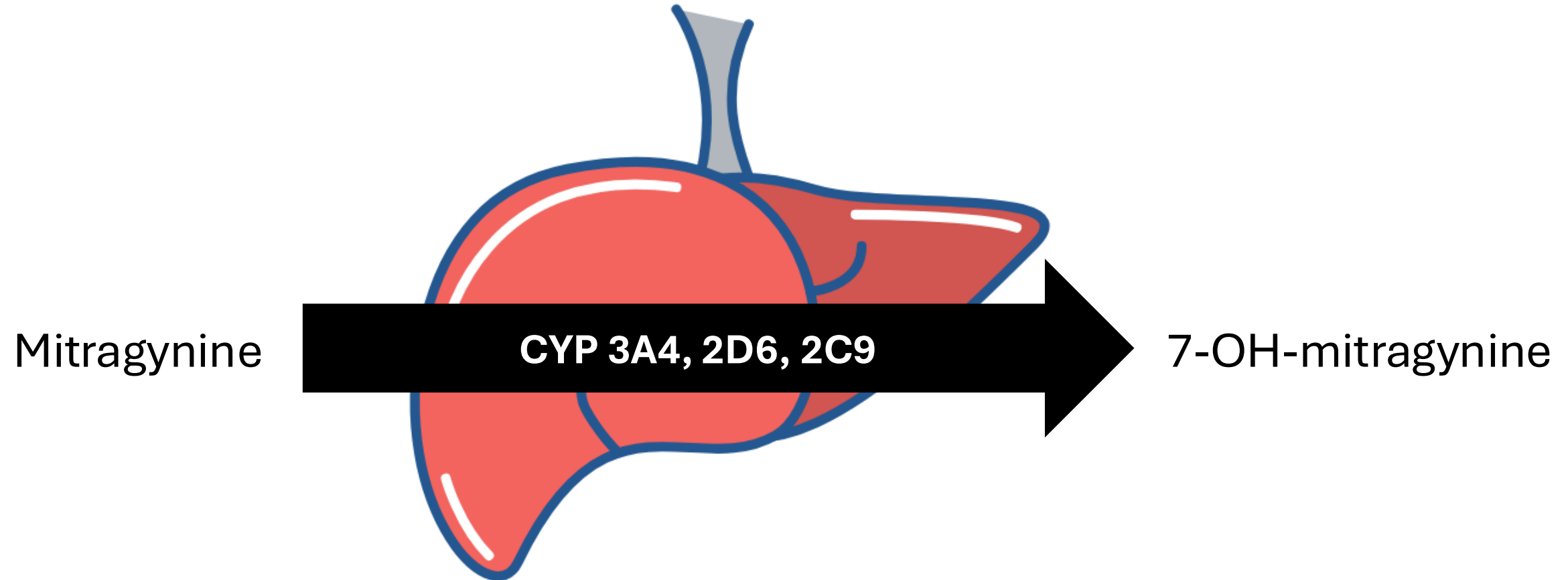

**(a) Midazolam**

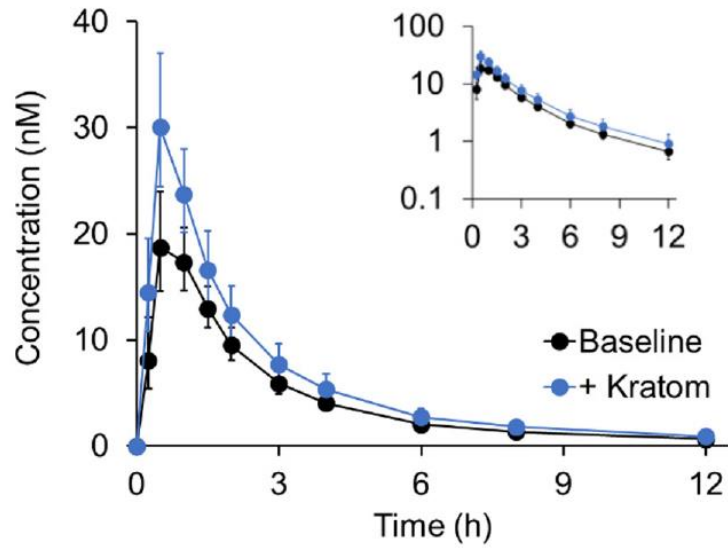

**(b) 1'-Hydroxymidazolam**

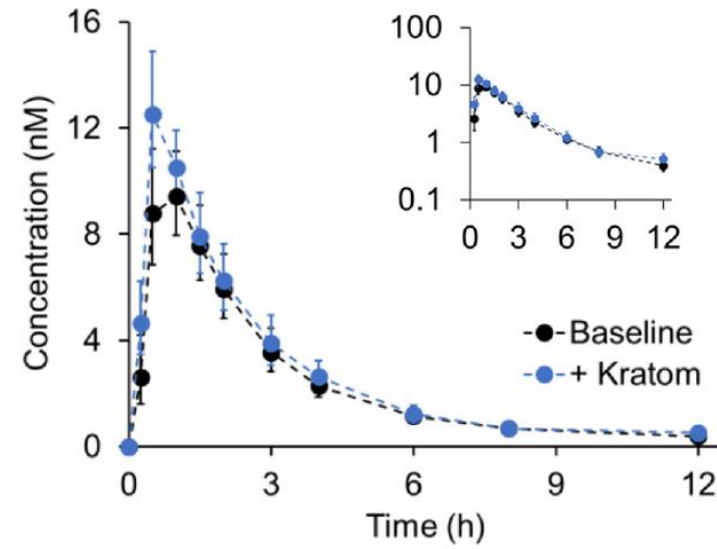

**(c) 4-Hydroxymidazolam**

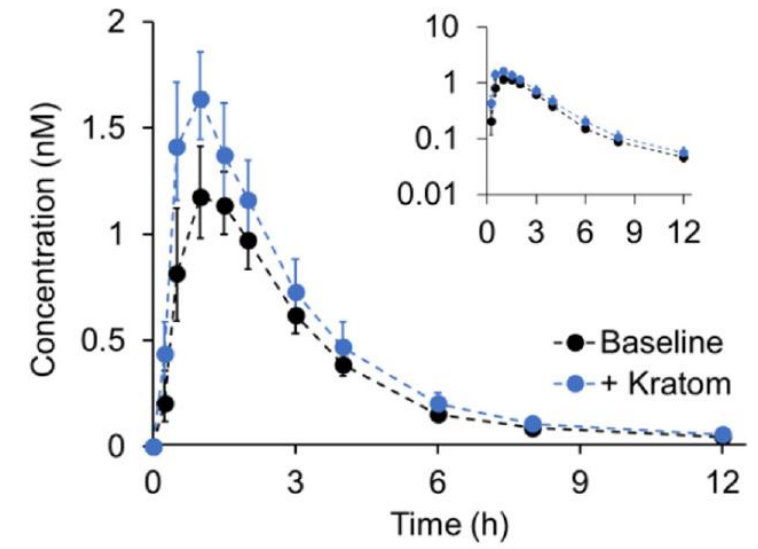

**(d) Dextromethorphan**

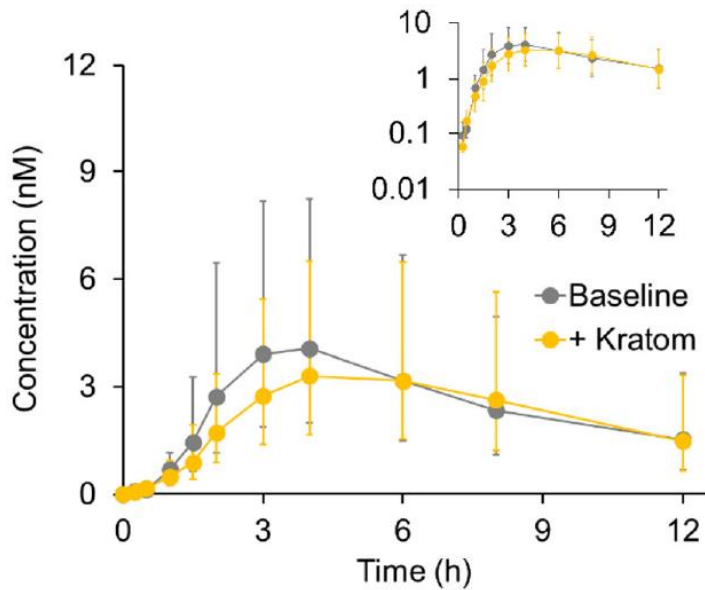

**(e) Dextrorphan**

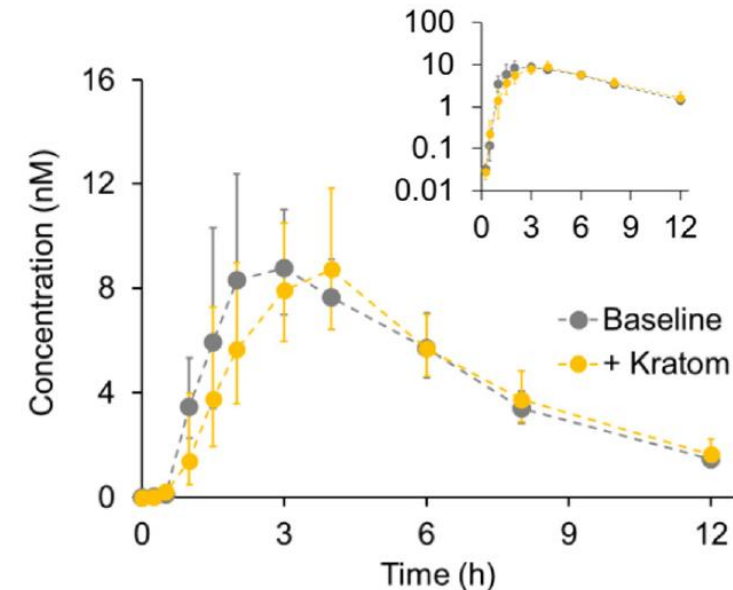

# Kratom Cardiotoxicity

QTc Interval	Mean QTc	Mean Serum Mitragynine
Normal (< 430 ms)	417.6 ms (n = 5)	5.9 mg/L
Prolonged (> 450 ms)	468.3 ms (n = 4)	15.9 mg/L*

\**p*-value = 0.045

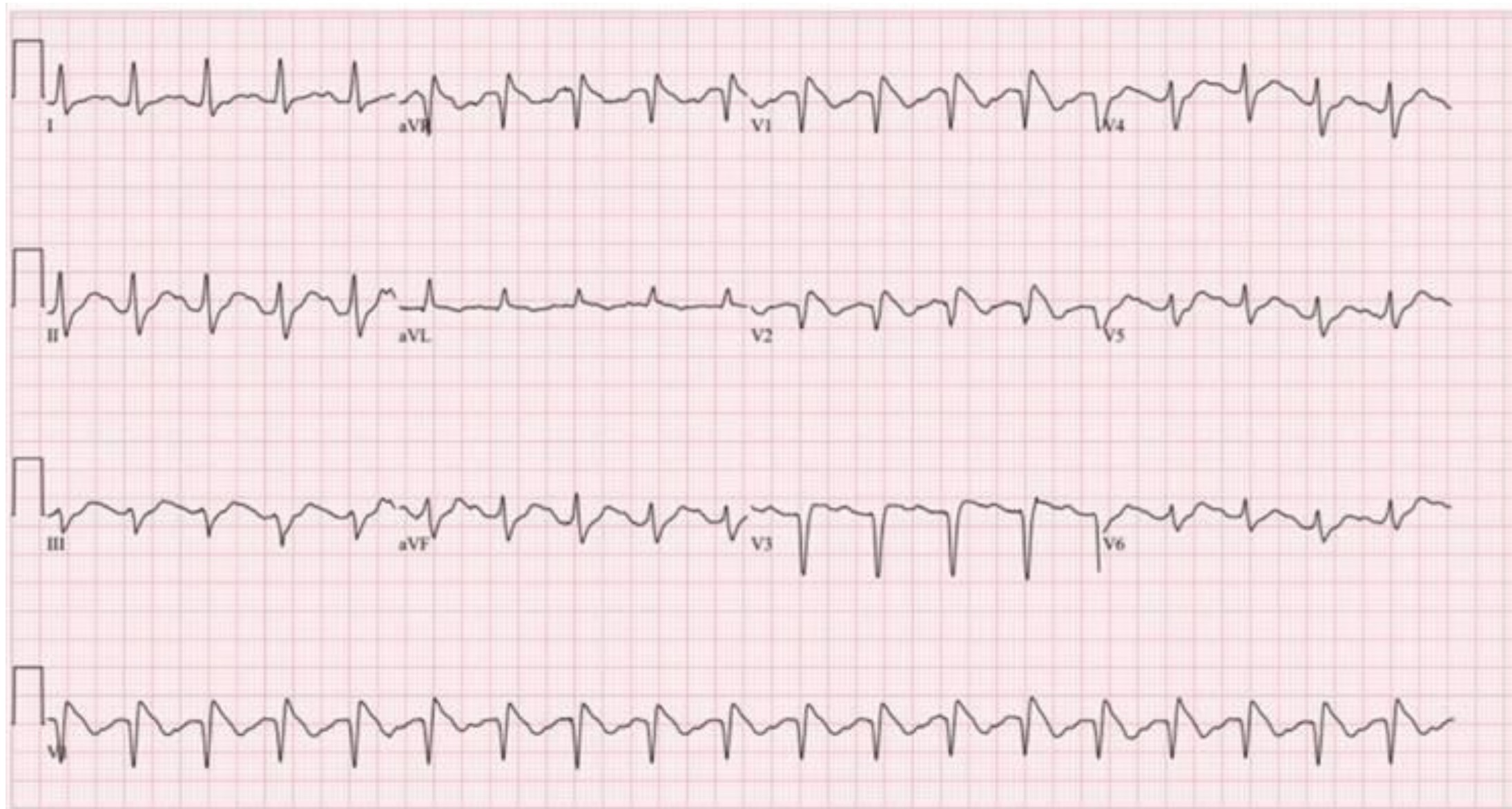

25mm/s 10mm/mV 40Hz 9.0.9 12SL 241 HD CID: 60

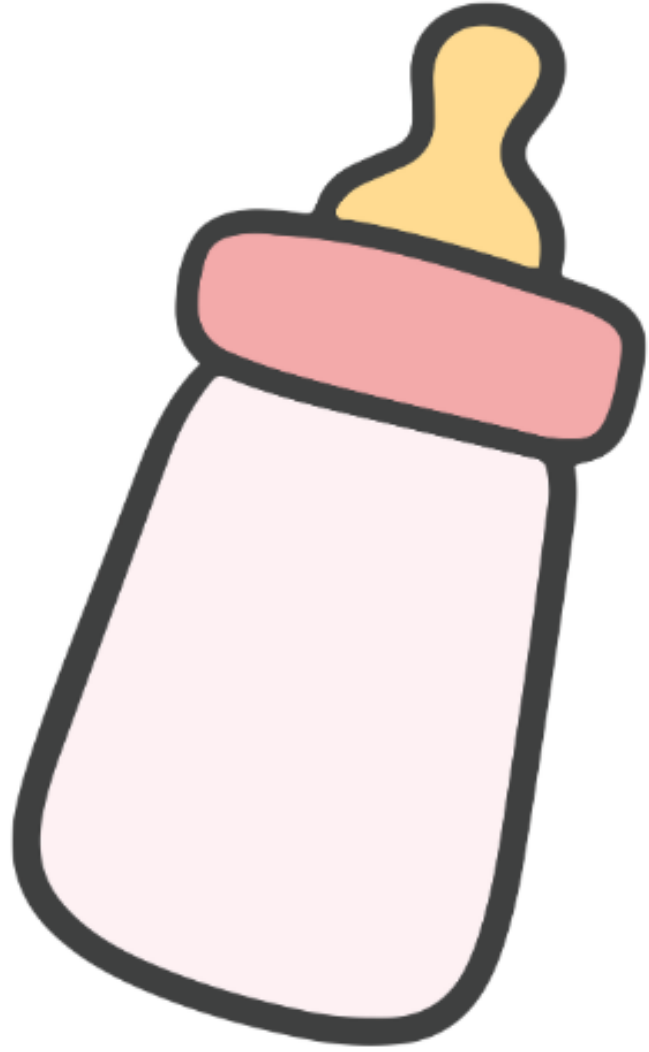

# Breastfeeding and NAS

	<b>Any Breastmilk</b>	<b>No Breastmilk</b>	<b>Adjusted <i>p</i>-value</b>
Treatment – median days (IQR)	14 (9 – 22)	17 (10 – 26)	0.04
Hospitalization – median days (IQR)	19 (13 – 28)	20 (13 – 31)	0.01
Re-admission – <i>n</i> (%)	7 (1.6)	17 (1.3)	0.3



# Substance Use Disorder

Lifetime Kratom Use

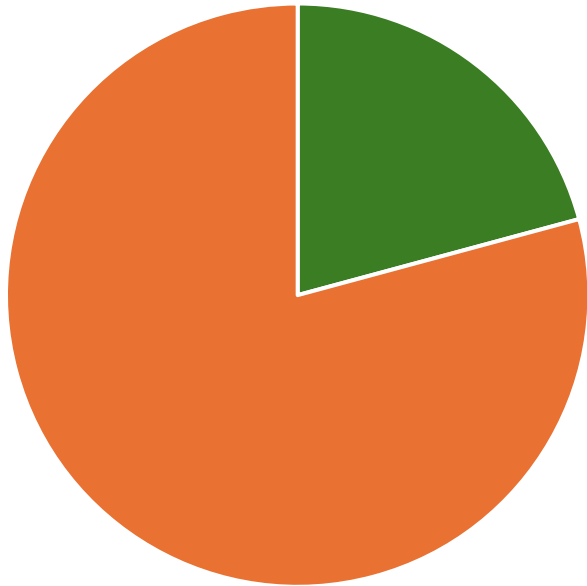

Kratom Use to Reduce NPO Use

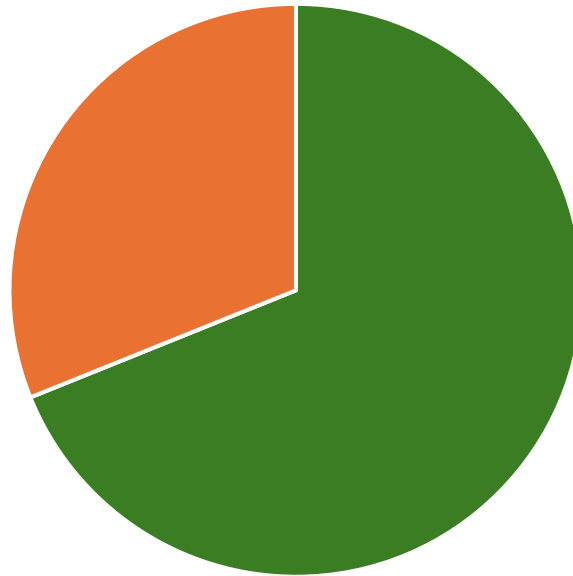

Non-Rx Buprenorphine Use

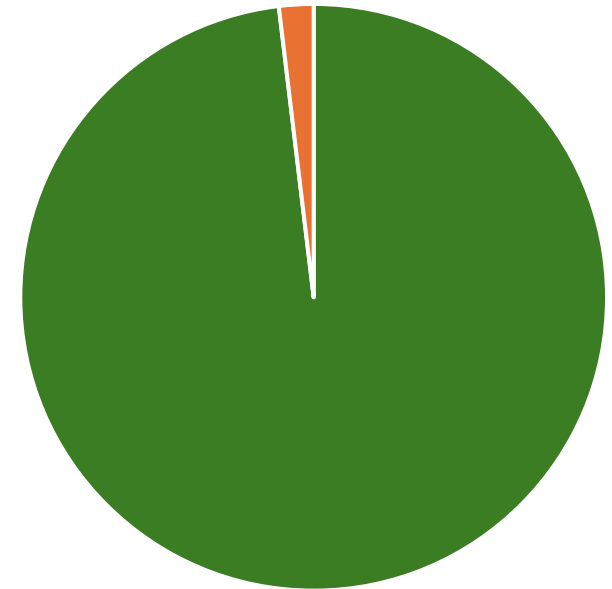

# Antinociception

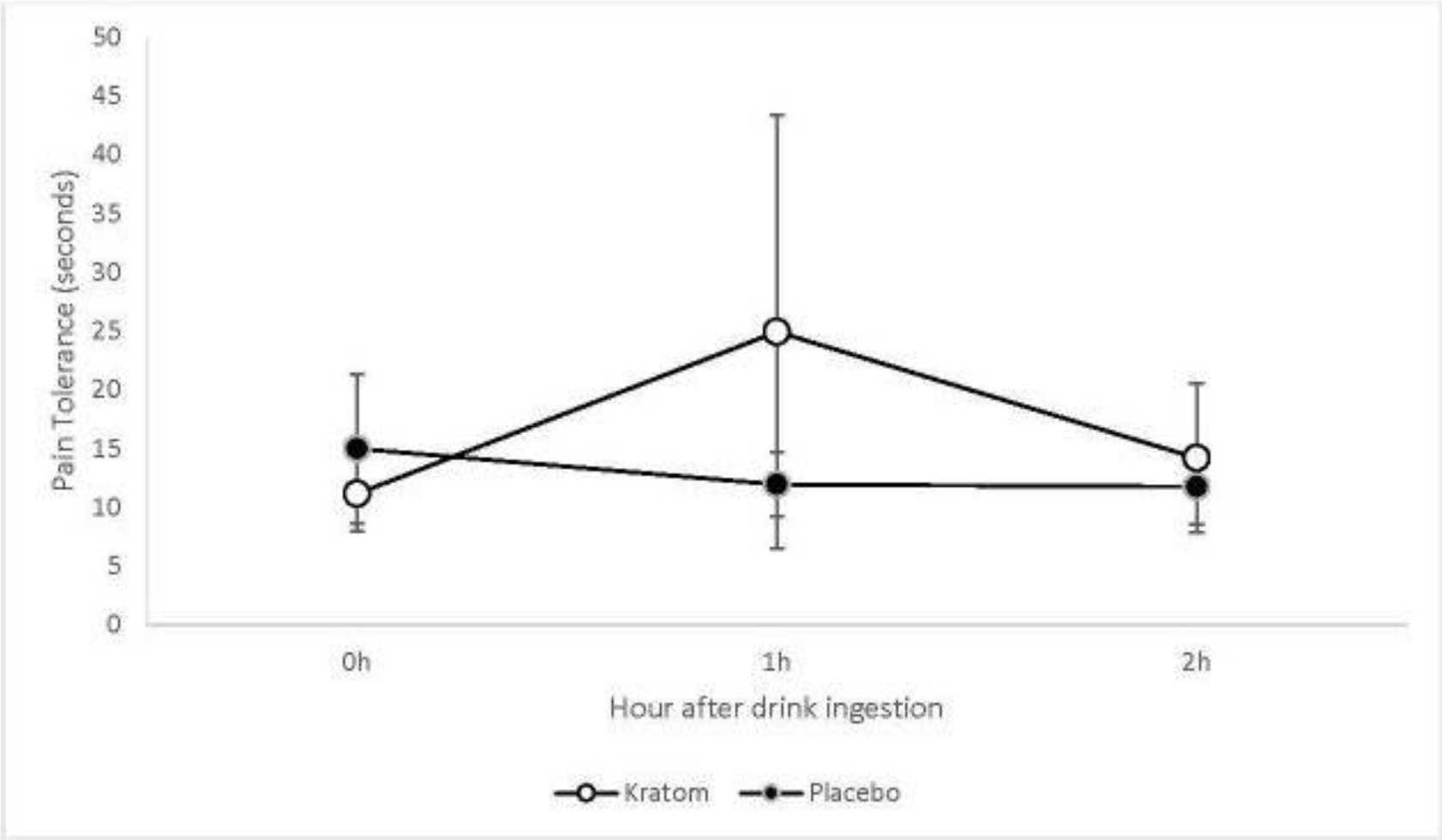

# Treating Withdrawal

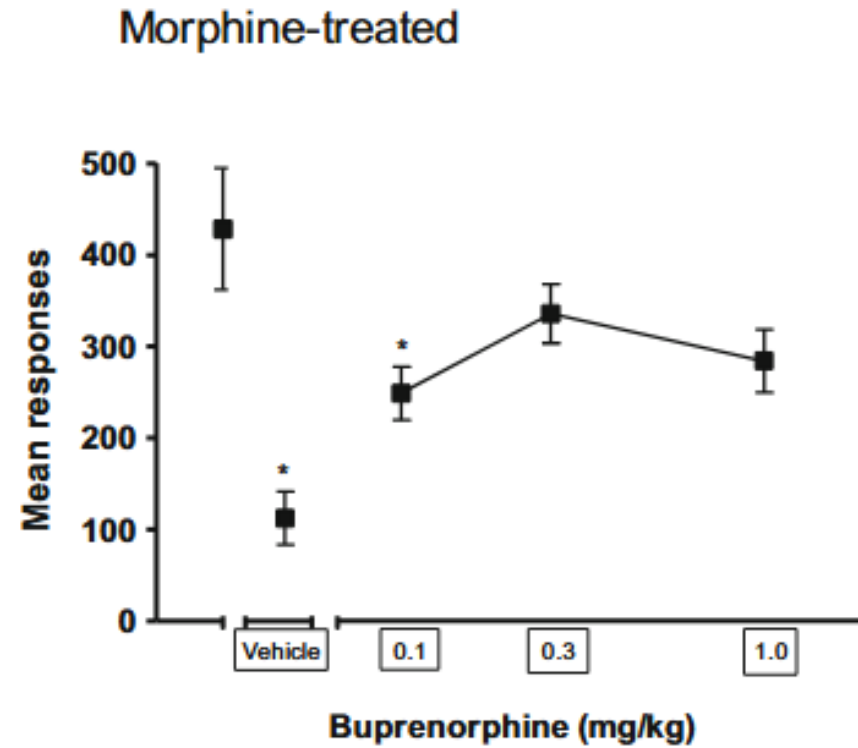
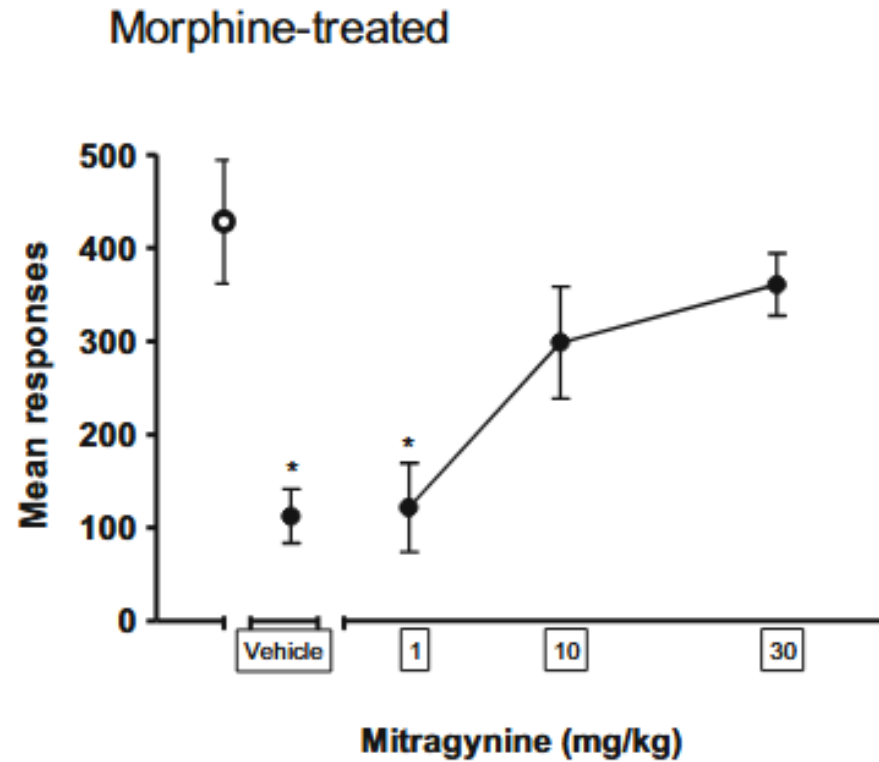

# Buprenorphine Dosing

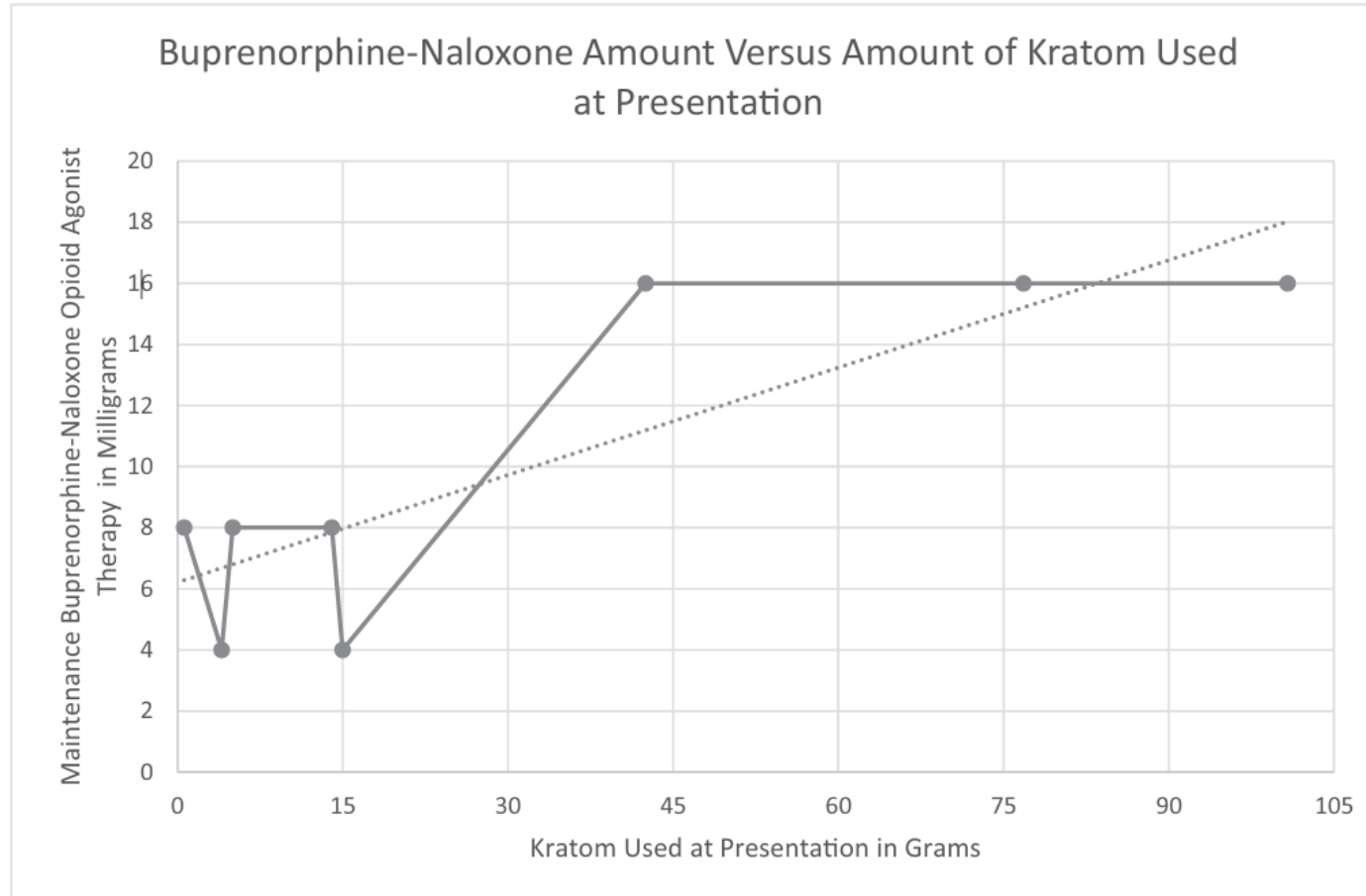

# Vendor Health Information

Is it clear what sources of information were used to compile the publication (other than the author or producer)?

**1.75/5**

Is it balanced and unbiased?

**2.06/5**

Does it refer to areas of uncertainty?

**2.02/5**

Does it describe the benefits of each treatment?

**2.36/5**

Does it describe the risks of each treatment?

**2.03/5**

# Marketing and Labeling

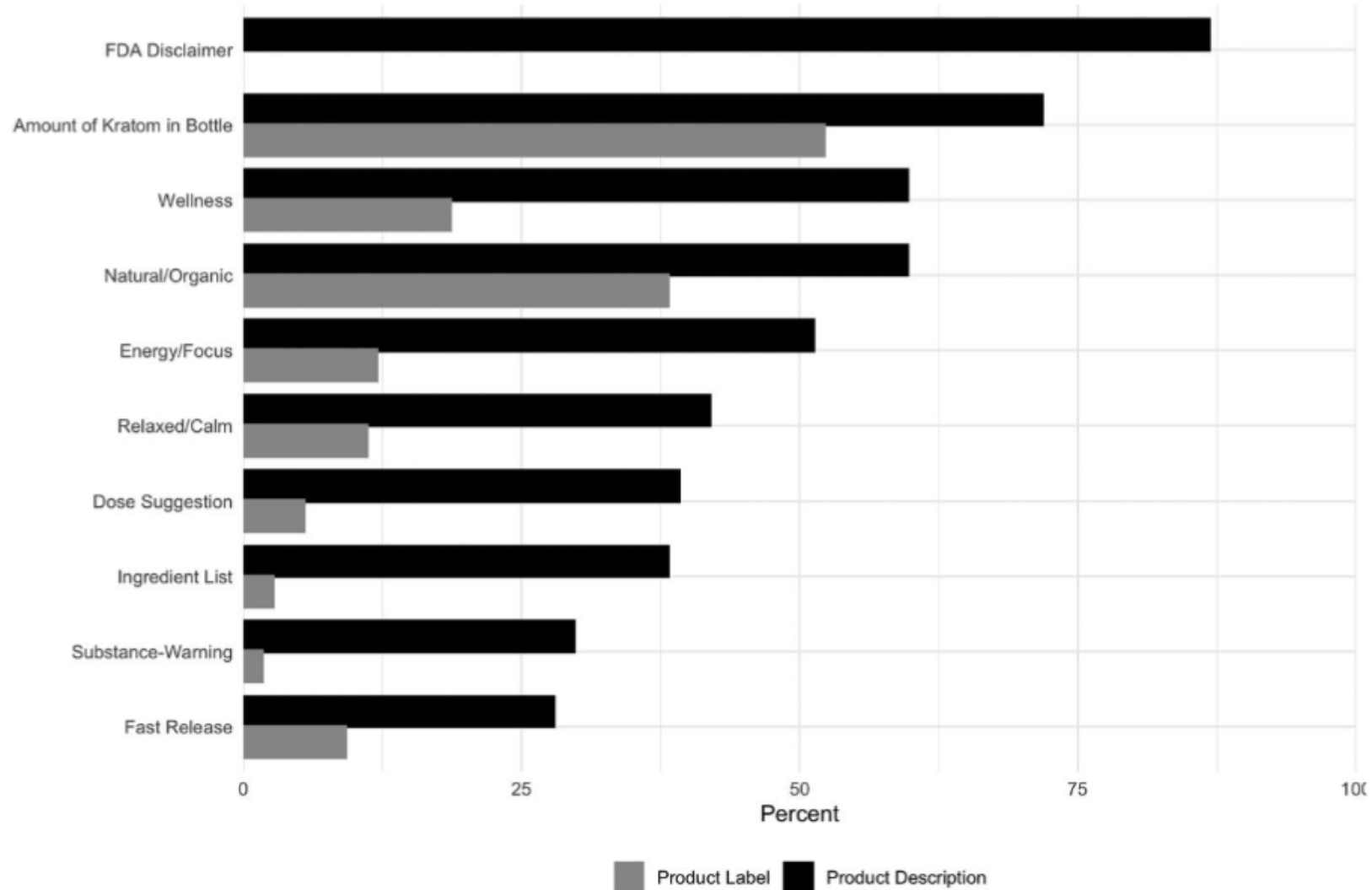

# Kratom Misbranding

Product ID	Mitragynine content, mg/g	7-HMG content, mg/g	7-HMG % label claim
Brand 1-1	4.0	28.0	118%
Brand 1-2	2.7	29.0	125%
Brand 1-3	5.6	25.3	107%
Brand 2-1	2.9	53.9	105%
Brand 2-2	3.2	55.6	108%
Brand 3	2.1	22.4	121%
Brand 4	14.6	74.7	107% (front) 128% (back)
Brand 5	2.1	29.9	109%



FDA NEWS RELEASE

# **FDA Takes Steps to Restrict 7-OH Opioid Products Threatening American Consumers**

*Agency alerts health care professionals and consumers of 7-hydroxymitragynine risks*

**For Immediate Release:** July 29, 2025



# Kratom Proposed Legislation

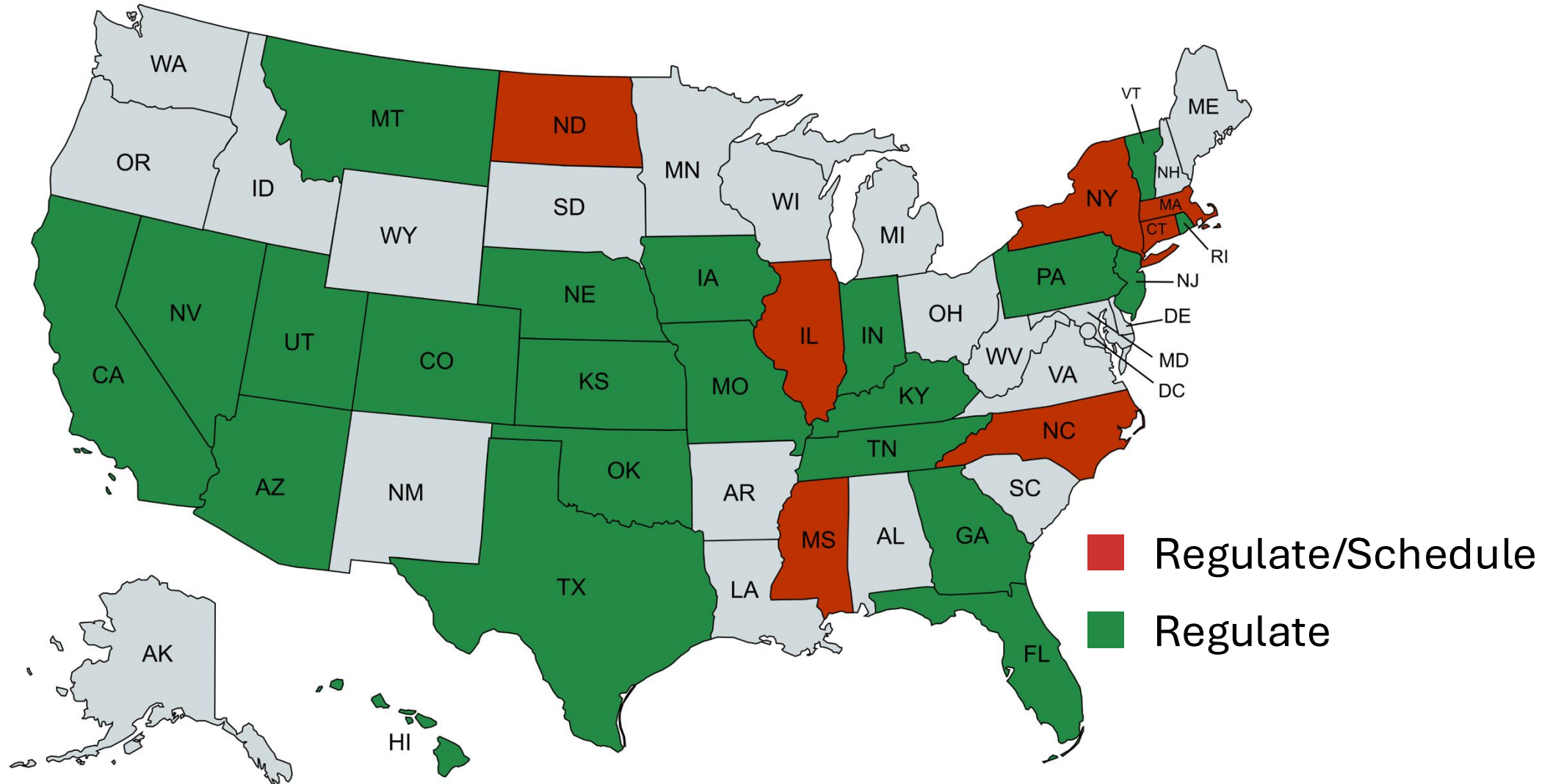





NDC 50580-317-06

# Imodium<sup>®</sup>

**A-D** Loperamide Hydrochloride Tablets, 2mg  
Anti-Diarrheal

*Anti-Diarrheal  
Caplets*

Controls the symptoms  
of diarrhea



Actual Size

**12 Caplets\***

\*Capsule-Shaped Tablets



